



MANUAL

SKYLANCER

IMPORTANTE

É DE EXTREMA IMPORTÂNCIA LER, COMPREENDER E SEGUIR TODAS AS INSTRUÇÕES CONTIDAS NESTE MANUAL. FALHAS OCACIONADAS PELO MANUSEIO INCORRETO PODEM DANIFICAR O EQUIPAMENTO E OCACIONAR A ANULAÇÃO DA GARANTIA.

CARACTERÍSTICAS

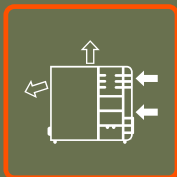
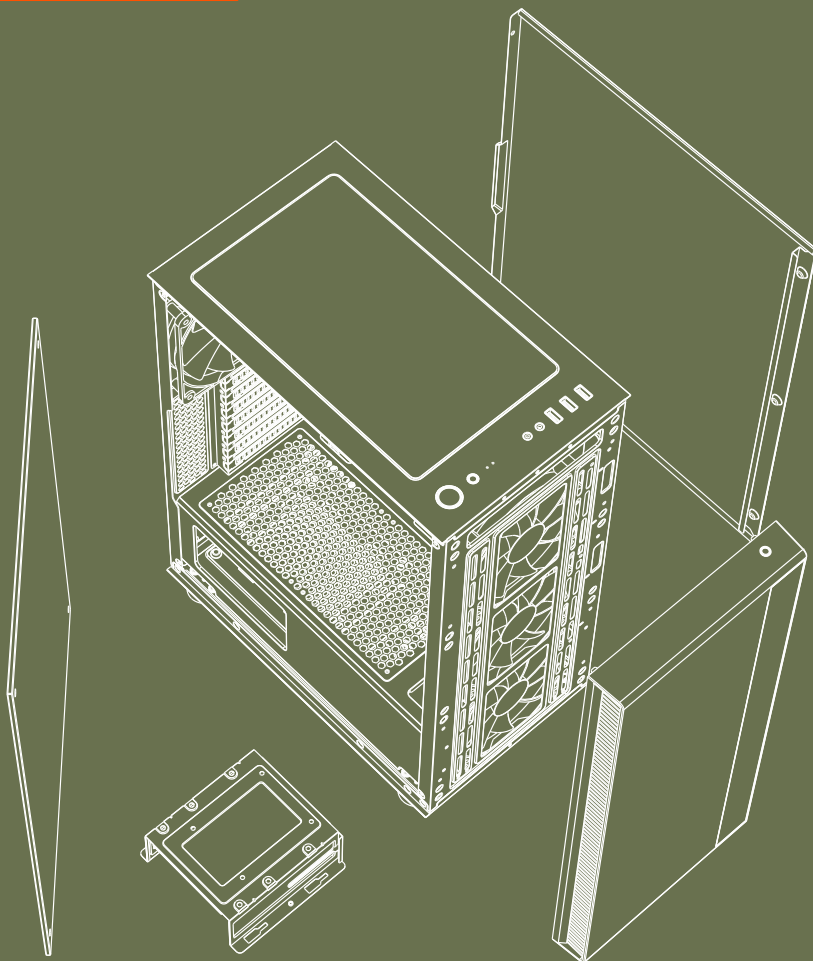

Fluxo de ar Otimizado



Ventoinha Inclusa



Vidro Temperado

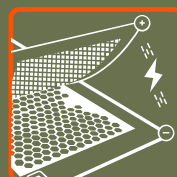

Filtro Magnético

ACESSÓRIOS

Item	Nome/Qtd	Uso
	Abraçadeiras x5	Gerenciamento de Cabos
 	Parafuso #6-32 6,5mm x3	Espaçador
 	Parafuso M3 5mm x14	Placa-Mãe / SSD
 	Parafuso #6-32 6mm x8	PSU / PCIe
 	Parafuso #6-32 5mm x8	3.5" HDD
 	Parafuso #7-3 4mm x2	3.5" HDD

INSTALAÇÃO DA FONTE DE ALIMENTAÇÃO

Remova os painéis laterais, e em seguida remova o painel frontal pela parte inferior do gabinete.

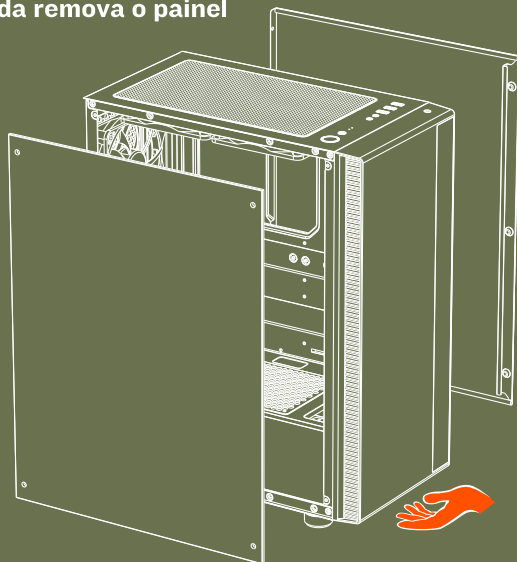

Certifique-se de que as furações da fonte de alimentação estejam alinhadas com as do gabinete, e fixe a fonte com os parafusos.

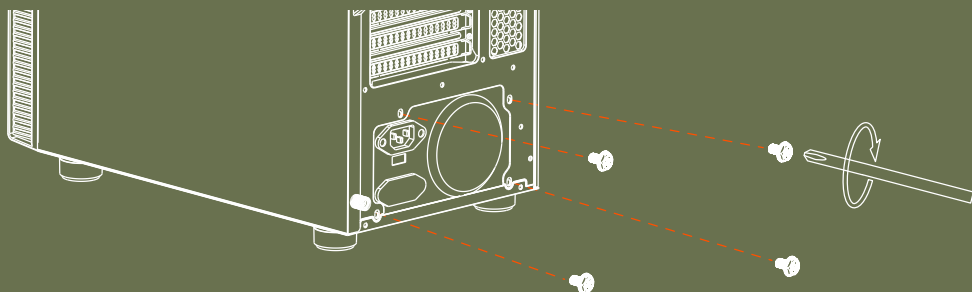

Parafuso #6-32 6mm

INSTALAÇÃO DA PLACA-MÃE E VENTOINHAS

Certifique-se de que a Placa-Mãe esteja alinhada com as furações/espaçadores e fixe a placa-mãe com os parafusos “M3 5mm”.



Parafuso M3 5mm
Placa-Mãe / SSD



Parafuso # 6-32 6,5 mm
Espaçador

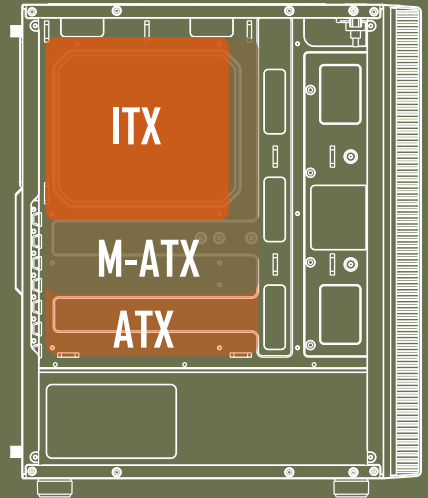

Superior: 2x120mm.

Traseira: 1 x 120mm.
ou
1 x Water Cooler
120mm.

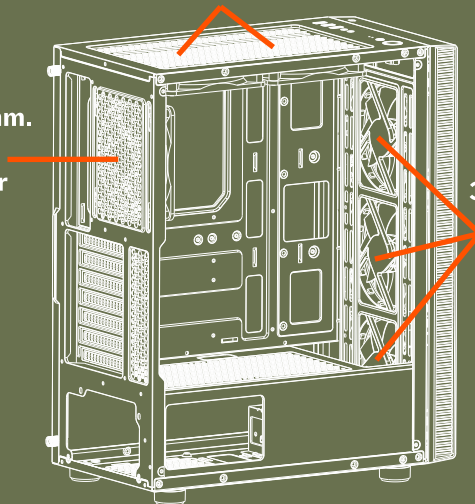

Frontal:
3 x 120mm / 2 x 140mm.
ou
1 x Water Cooler
240mm / 280mm.

INSTALAÇÃO DO HDD

Acesse a baia de armazenamento pela lateral direita, e desparafuse-a pela parte inferior do gabinete.

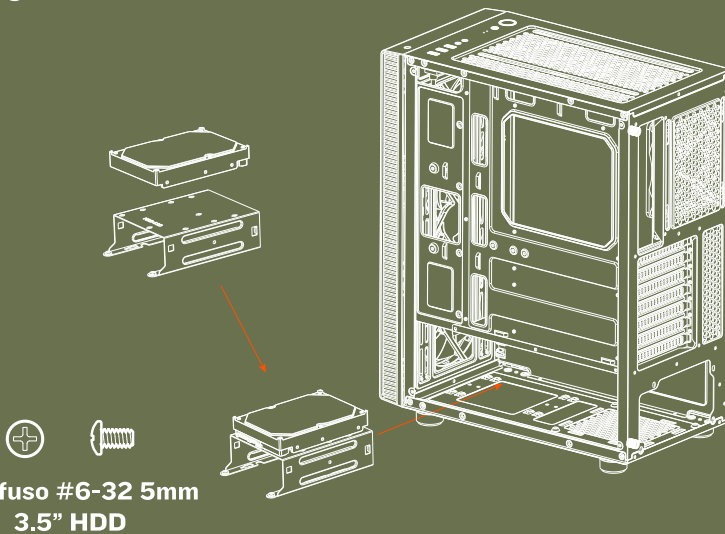

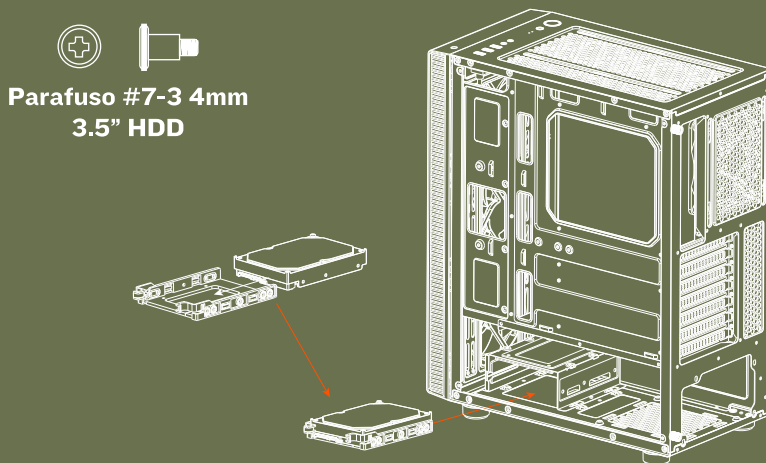

Nota: É possível instalar 2 x HDD's ou 1 x HDD + 1 x SSD na baia de armazenamento



INSTALAÇÃO DO SSD E PLACA DE VÍDEO

Posicione os SSD'S nos locais indicados conforme a imagem, e fixe-os com os parafusos.

 
Parafuso M3 5mm
Placa-Mãe / SSD

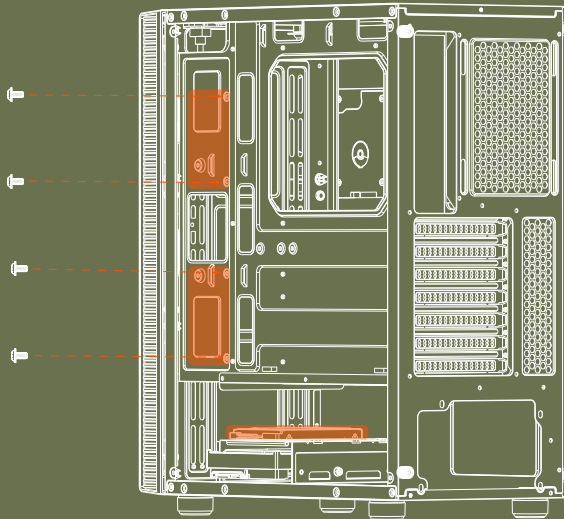

Identifique quantos slots PCI-e o modelo de Placa de Vídeo utiliza, e remova-os. Encaixe a Placa de Vídeo na Placa-Mãe e fixe o espelho com os parafusos.

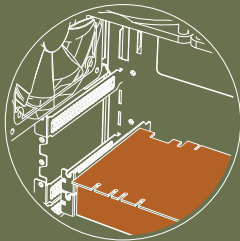

 
Parafuso #6-32 6 mm
PSU / PCI-e

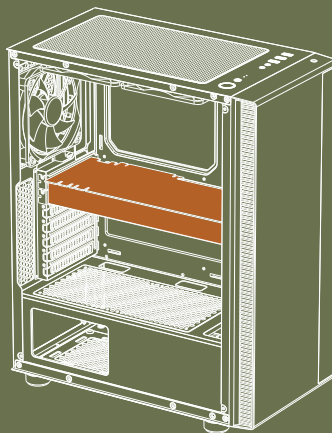

PAINEL FRONTAL E CONECTORES

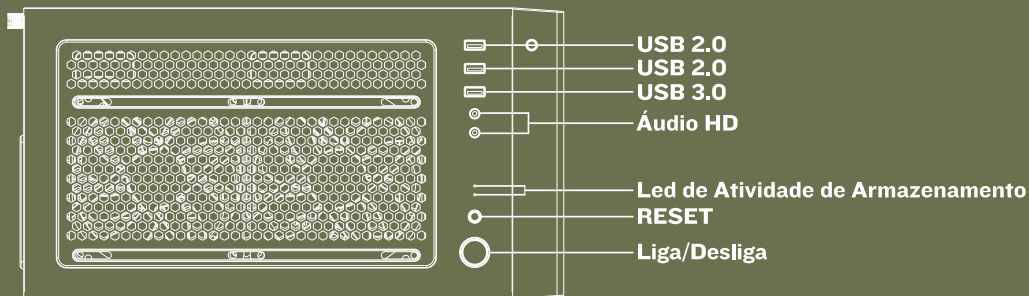

Conectores de Áudio HD



Conectores USB



Conectores USB 3.0

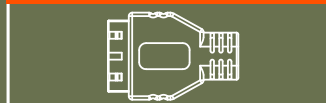

Conectores de Áudio HD da Placa Mãe

PORT1L	■	AUD GND
PORT1R	■	PRESENSE#
PORT2R	■	SENSE1 RETURN
SENSE SEND	■	NO PIN
PORT2L	■	SENSE RETURN

Conectores USB da Placa Mãe

VCC	■	VCC
D-	■	D-
D+	■	D+
GND	■	GND
	■	NC

Conectores USB 3.0 da Placa Mãe



H.D.D LED



+P LED



-P LED



POWER SW



**AGRADECEMOS POR ESCOLHER O PICHAU GROUP
COMO PARTE DA SUA JORNADA.**



Pichau

**EXPLORE NOSSOS SITES E ENCONTRE O
PRODUTO IDEAL PARA ELEVAR SUA EXPERIÊNCIA.**

